



# Product Description

## MASTER MHN-SE

Very compact quartz metal halide lamps with single-pinch GX-22 lamp cap

### Benefits

- Allows compact, highly efficient luminaire systems with high-precision optics for good beam control and minimal light spill
- Very good colour rendering creates a pleasant ambience with high visual comfort for players and spectators
- Continuous spectral distribution offers a superior solution for professional stadiums with regular TV coverage

### Features

- Single-pinch concept for superior optical performance
- High luminous efficacy
- Natural white colour appearance, very good colour rendering and good colour stability
- Daylight colour temperature eases transition from daylight to artificial lighting

### Application

- Professional sports lighting

### Warnings and Safety

- Use only in totally enclosed luminaire, even during testing (IEC61167, IEC 62035, IEC60598)
- The luminaire must be able to contain hot lamp parts if the lamp ruptures
- A lamp breaking is extremely unlikely to have any impact on your health. If a lamp breaks, ventilate the room for 30 minutes and remove the parts, preferably with gloves. Put them in a sealed plastic bag and take it to your local waste facilities for recycling. Do not use a vacuum cleaner.

**PHILIPS**

Related products



MHN-SE, GX22, HO

Dimensional drawing

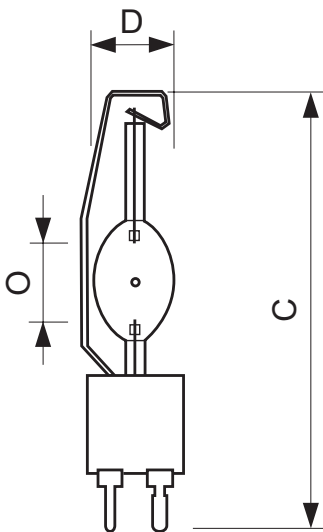

MASTER MHN-SE 2000W/956 GX22 400V HO

Product	C (Max)	D (Max)	O (Norm)
MHN-SE 2000W/956 GX22 400V HO	198	41	25

General Characteristics

Order code	Full product name	Cap-Base	Bulb	Bulb Finish	Burning Position	Life to 5% failures	Life to 10% failures	Life to 20% failures	Life to 50% failures
928778 00	MASTER MHN-SE 2000W/956 GX22 400V HO	GX22	TD40	Clear	any	1300 hr	1650 hr	2100 hr	3000 hr

Installation diagrams

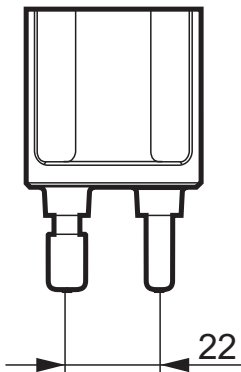

GX22

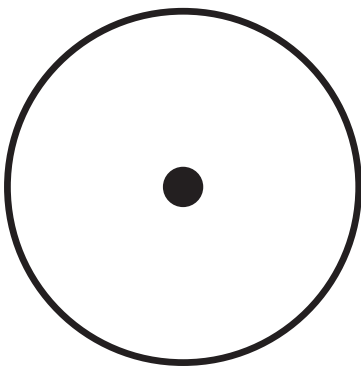

any

Light Technical Characteristics (1/2)

Order code	Full product name	Colour Code	Colour Rendering Index	Colour Designation	Colour Temperature	Lamp Luminous Flux EM	Lamp Luminous Efficacy EM	Lumen Maintenance 1000h	Lumen Maintenance 2000h	Lumen Maintenance 5000h	Chromaticity Coordinate X
928778 00	MASTER MHN-SE 2000W/956 GX22 400V HO	956	84 Ra8	Daylight	5600 K	220000 Lm	108 Lm/W	95 %	91 %	%	338 -

Light Technical Characteristics (2/2)

Order code	Full product name	Chromaticity Coordinate Y
928778 00	MASTER MHN-SE 2000W/956 GX22 400V HO	368 -

Electrical Characteristics

Order code	Full product name	Lamp Wattage	Lamp Wattage EM 25°C, Nominal	Lamp Wattage EM 25°C, Rated	Voltage	Lamp Voltage	Lamp Current EM	Dimmable
928778 00	MASTER MHN-SE 2000W/956 GX22 400V HO	2000 W	2000.0 W	2100.0 W	400 V	210 V	11.2 A	no

Performance diagrams

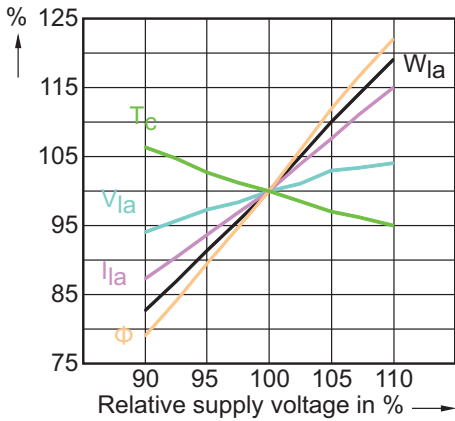

MHN-SE 2000W HO

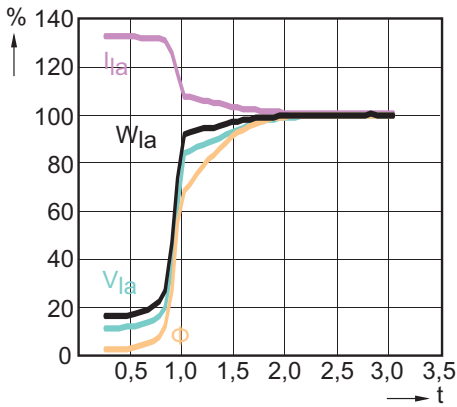

MHN-SE 2000W HO

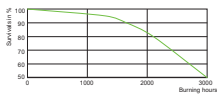

MHN-SE 2000 W Life Expectancy /956 HO

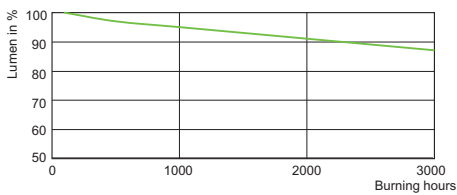

MHN-SE 2000 W Lumen Maintenance /956 HO

## Environmental Characteristics

Order code	Full product name	Energy Efficiency Label (EEL)	Mercury (Hg) Content	Energy consumption kWh/1000h
928778 00	MASTER MHN-SE 2000W/956 GX22 400V HO	A+	215 mg	2310 kWh

## Luminaire Design Requirements

Order code	Full product name	Bulb Temperature
928778 00	MASTER MHN-SE 2000W/956 GX22 400V HO	1015 (max) C



© 2015 Koninklijke Philips N.V. (Royal Philips)  
All rights reserved.

Specifications are subject to change without notice. Trademarks are the property of Koninklijke Philips N.V. (Royal Philips) or their respective owners.

[www.philips.com/lighting](http://www.philips.com/lighting)

2015, September 22  
data subject to change