



PHILIPS

MASTER
LEDspot MV



Technical Application Guide

Philips MASTER 230V dimmable PAR30 9.5-90W

PHILIPS 230V dimmable PAR30 9.5-90W with Technology provides an excellent performances with optimal thermal efficiency and a compact high efficiency driver in a sleek, lightweight design perfectly fitting into a traditional halogen form-factor. It offers a light intensity and quality with an elegant design solution for a seamless looks besides employing a hi-tech IC solution to ensure excellent dimming system control.

The form-factor of the PHILIPS 230V dimmable PAR30 9.5-90W guarantees a 100% form-fit. 230V dimmable PAR30 9.5-90W is ideal for a myriad of applications including track lighting, general architectural and accent lighting, plus industrial OEM equipment lighting.



www.philips.com/masterledlamps





Design highlights

- Up to 89% energy savings compared to standard halogen and incandescent spot lamps
- Long lifetime of 40,000 hours (F50, L70)
- Fits into most of PAR30 fixtures
- Dimmable when using leading and trailing edge dimmers
- Optimum beam spread of 25 degree
- CCT: 2700K
- Virtually UV/IR free in the beam
- Lowers maintenance costs by reducing re-lamp frequency
- Environmental friendly, without Mercury or any other hazardous substances
- RoHS compliant

Application areas

PHILIPS 230V dimmable PAR30 9.5-90W lamp is designed for spot and general lighting applications in retail and hospitality markets. Unlike the conventional halogen reflector lamp, PHILIPS 230V dimmable PAR30 9.5-90W lamp, 9.5W power consumption per lamp, has a long lifetime of 40,000 hours ensuring minimum maintenance cost in shops, hotels, restaurants and cafes. The beautiful light and elegant design makes the PHILIPS LED PAR30 Lamps especially suited for various applications such as:

- Retail sales/picture windows/feature displays
- Corridors/Stairway/Washroom
- Lobby / Reception areas

Application notes

- Operating open air ambient temperature range is -20°C to 40°C
- This device is not intended for use with emergency exit fixtures or emergency lights
- For use in fixtures that can structurally support weight of a lamp

Product features

Technical Specifications

Product type	Voltage (VAC)	Power Watts (W)	Base	Lumen Output (90° ϕ) (lm)	Lumen (lm)	Beam Angle ($^{\circ}$)	CCT (K)	Intensity (Cd)	Lifetime (Hrs)	CRI	Dimmable
MASTER LEDspot D 9.5-90W 827 PAR30S 25D	230	9.5	E27	815	845	25	2700	3500	40,000	80	Yes

Fixture Compatibility

PHILIPS dimmable PAR30 9.5-90W LED lamps is compatible with most Halogen PAR30 lighting fixtures.

Type	C max. Overall Length (mm)	D max. Diameter (mm)	max. Weight (kg)
230V dimmable PAR30S 9.5W	93	92	0.248

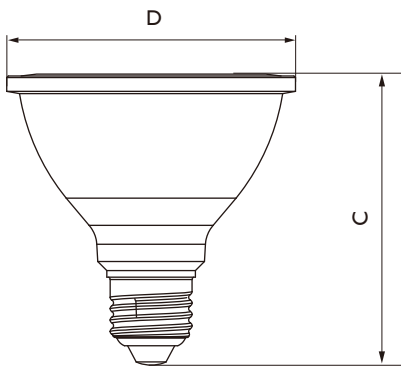

Spectral Power Distribution

Spectrum PAR30S 25D 2700K 9.5-90W

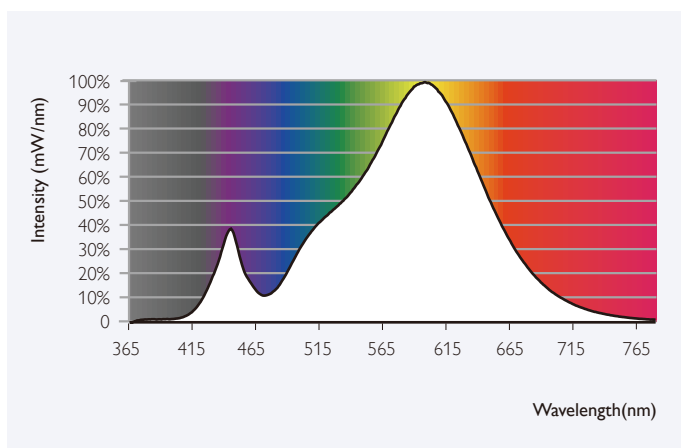

Temperature

- PHILIPS 230V dimmable PAR30 9.5-90W is designed for operation in all PAR30 lighting installations.
- Maximum case temperature for rated 40,000 hr lifetime: 65°C.

Dimmable PAR30 9.5-90W LED Lamps

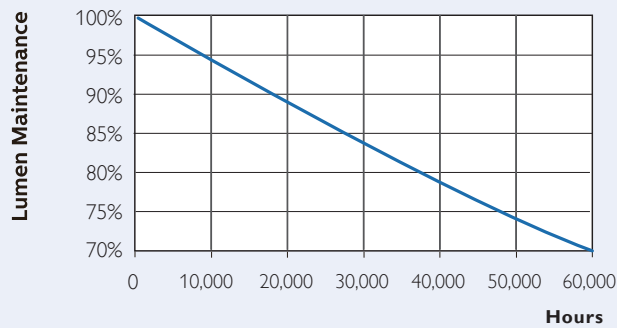
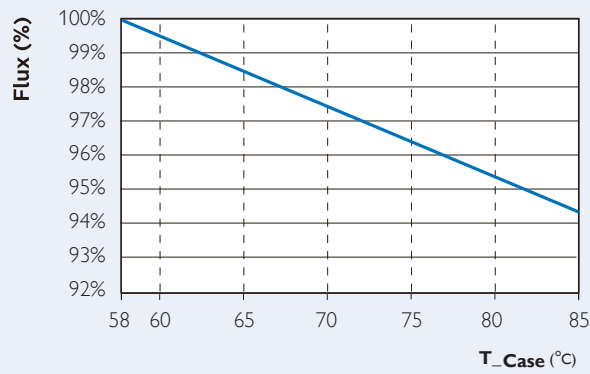

Photometric Diagrams

MASTER LEDspot D 9.5-90W 827 PAR30S 25D

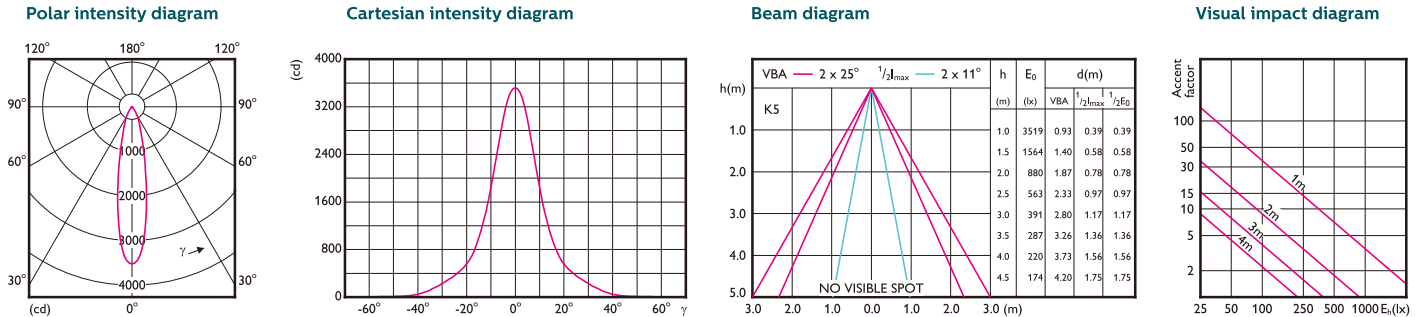

Lifetime + Sustainability

Failure Rate Curve of 230V Dimmable PAR30 9.5-90W

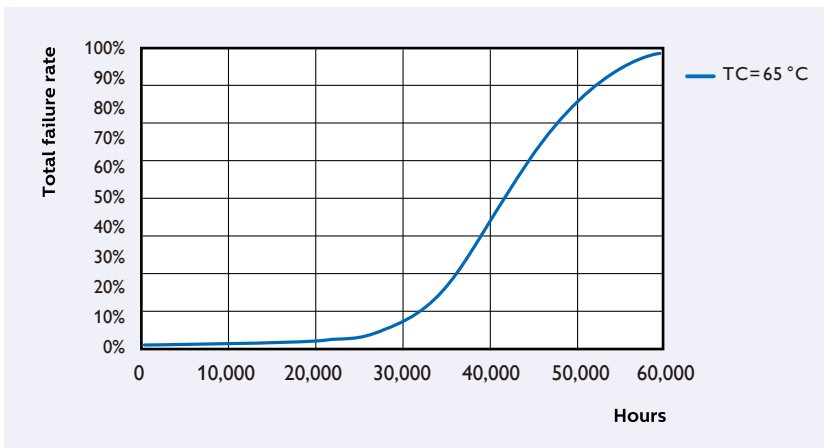

- PHILIPS dimmable PAR30 9.5-90W lamp has a lifetime of 40,000 hours at $T_c=65^\circ\text{C}$, defined as the number of hours when 50% of a large group of identical lamps drop below 70% of its initial lumens.

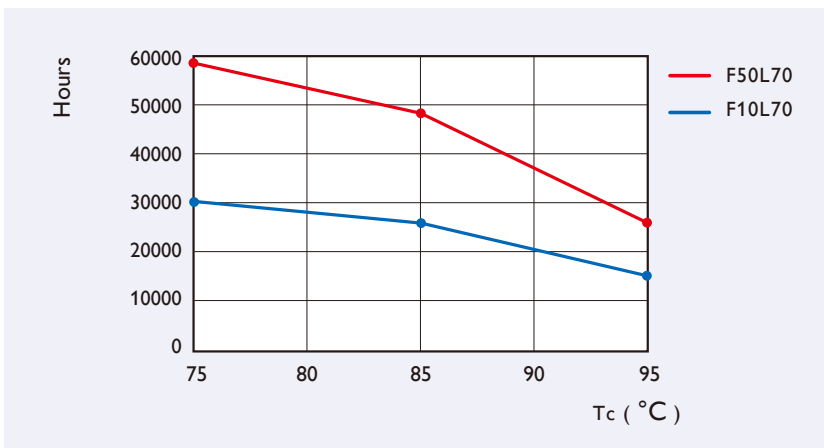

- Lifetime estimation based on the application environment condition: please refer to the T_c for lifetime forecast.



© 2015 Philips Lighting. All rights reserved. Reproduction in whole or in part is prohibited without the prior written consent of the copyright owner. The information presented in this document does not form part of any quotation or contract, is believed to be accurate and reliable and may be changed without notice. No liability will be accepted by the publisher for any consequence of its use. Publication thereof does not convey nor imply any license under patent or other industrial or intellectual property rights.

www.philips.com/masterledlamps